

### Features

- Trench IGBT technology
  - Low  $V_{CE(on)}$
  - Low switching losses
  - Positive  $V_{CE(on)}$  temperature coefficient
- Free wheeling diodes with fast and soft reverse recovery
- Industrial standard package with copper base plate

### Applications

- Welder / Power Supply
- UPS / Inverter
- Industrial Motor Driver

### Target data

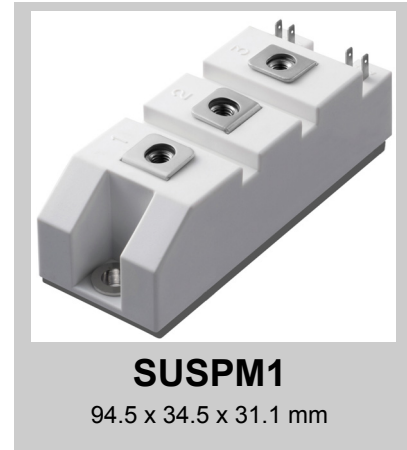

### Absolute Maximum Ratings $T_C = 25^\circ\text{C}$ unless otherwise noted

Item	Symbol	Conditions	Value	Units
IGBT	$V_{CES}$		600	V
	$V_{GES}$		$\pm 20$	V
	$I_C$	@ $T_j = 175^\circ\text{C}$ , $T_C = 25^\circ\text{C}$ , Continuous	180	A
		@ $T_j = 175^\circ\text{C}$ , $T_C = 65^\circ\text{C}$ , Continuous	150	A
	$I_{CM}$	@ $T_C = 65^\circ\text{C}$ , $t_p = 1\text{ ms}$	300	A
	$T_j$	Operating Junction Temperature <sup>(1)</sup>	-40~125	$^\circ\text{C}$
$P_D$	@ $T_j = 175^\circ\text{C}$ , $T_C = 25^\circ\text{C}$	500	W	
	@ $T_j = 175^\circ\text{C}$ , $T_C = 80^\circ\text{C}$	300	W	
Diode	$V_{RRM}$		600	V
	$I_F$		150	A
	$I_{FRM}$	$t_p = 1\text{ ms}$	300	A
	$T_j$	Operating Junction Temperature <sup>(1)</sup>	-40~125	$^\circ\text{C}$
Module	$T_{stg}$	Storage Temperature	-40~125	$^\circ\text{C}$
	$V_{iso}$	@AC 1minute	2500	V
	$M_t$	Main Terminal Mounting torque (M5)	2.5~5	Nm
	$M_S$	Heat sink Mounting torque (M6)	3.0~5	Nm
	$W$	Weight	180	g

### Internal Circuit & Pin Description

Pin Number	Pin Name	Pin Description
1	C2E1	Output
2	E2	Negative DC Link Output
3	C1	Positive DC Link Output
4	G1	Gate Input for High-side
5	E1	Emitter Input for High-side
6	G2	Gate Input for Low-side
7	E2	Emitter Input for Low-side

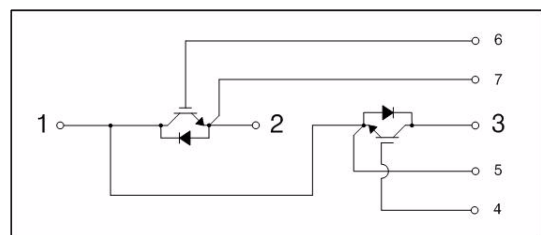

(Note \*1) The Maximum junction temperature of chip is 175 $^\circ\text{C}$   
 (Note \*2) The value was calculated. In other word, It was not measured.

## Electrical Characteristics of IGBT $T_C = 25^\circ\text{C}$ unless otherwise noted

### Static Characteristics

Symbol	Parameter	Test Conditions	Min	Typ	Max	Units
$BV_{CES}$	C-E Breakdown Voltage	$V_{GE} = 0\text{ V}, I_C = 250\ \mu\text{A}$	600	-	-	V
$I_{CES}$	C-E Cut-Off Current	$V_{CE} = V_{CES}, V_{GE} = 0\text{ V}$	-	-	250	$\mu\text{A}$
$I_{GES}$	G-E Leakage Current	$V_{GE} = V_{GES}, V_{CE} = 0\text{ V}$	-	-	-	nA
$V_{GE(th)}$	G-E Threshold Voltage	$V_{GE} = V_{CE}, I_C = 150\text{ mA}$	-	7.5	-	V
$V_{CE(sat)}$	Collector to Emitter Saturation Voltage	$I_C = 150\text{ A}, V_{GE} = 15\text{ V}, T_C = 25^\circ\text{C}$	-	1.9	-	V
		$I_C = 150\text{ A}, V_{GE} = 15\text{ V}, T_C = 125^\circ\text{C}$	-	2.3	-	V

### Dynamic Characteristics

Symbol	Parameter	Test Conditions	Min	Typ	Max	Units
$I_{SC}$	Short Current	$V_{GE} \leq 15\text{ V}, V_{CC} = 400\text{ V}$ $V_{CE} \leq V_{CES}, T_J = 125, T_P \leq 5.5\ \mu\text{s}$	-	400	-	A
$C_{ies}$	Input Capacitance	$V_{CE} = 30\text{ V}, V_{GE} = 0\text{ V}$ $f = 1\text{ MHz}, T_C = 25^\circ\text{C}$	-	9.9	-	nF
$C_{oes}$	Output Capacitance		-	0.5	-	nF
$C_{res}$	Reverse Transfer Capacitance		-	0.3	-	nF
$t_d(on)$	Turn-On Delay Time	$T_C = 125^\circ\text{C}, R_G = 30\ \Omega$ $L = 100\ \mu\text{H}, V_{DC} = 300\text{ V}$ $V_{GE} = 15\text{ V} \sim -15\text{ V}$ $I_C = 150\text{ A}$	-	323	-	ns
$t_r$	Rise Time		-	203	-	ns
$t_d(off)$	Turn-Off Delay Time		-	343	-	ns
$t_f$	Fall Time		-	45	-	ns
$E_{on}$	Turn-On Switching Loss		-	14.1	-	mJ
$E_{off}$	Turn-Off Switching Loss		-	3.1	-	mJ
$E_{ts}$	Total Switching Loss		-	17.2	-	mJ
$Q_g$	Total Gate Charge	$V_{GE} = 0\text{ V} \sim +15\text{ V}$	-	330	-	nC
$Q_{ge}$	Gate-Emitter Charge		-	125	-	nC
$Q_{gc}$	Gate-Collector Charge		-	150	-	nC

### Electrical Characteristics of Diode $T_C = 25^\circ\text{C}$ unless otherwise noted

Symbol	Parameter	Test Conditions	Min	Typ	Max	Units	
$V_F$	Diode Forward Voltage	$I_F = 150\text{ A}$ $V_{GE} = 0\text{ V}$	$T_C = 25^\circ\text{C}$	-	1.6	-	V
			$T_C = 125^\circ\text{C}$	-	1.5	-	
$t_{rr}$	Diode Reverse Recovery Time	$R_G = 30\ \Omega$ $L = 100\ \mu\text{H}$ $V_{DC} = 300\text{ V}$ $V_{GE} = 15\text{ V} \sim -15\text{ V}$ $I_C = 150\text{ A}$	$T_C = 25^\circ\text{C}$	-	334	-	ns
			$T_C = 125^\circ\text{C}$	-	459	-	
$I_{RRM}$	Diode Peak Reverse Recovery Current		$T_C = 25^\circ\text{C}$	-	33	-	A
			$T_C = 125^\circ\text{C}$	-	46	-	
$Q_{rr}$	Diode Reverse Recovery Charge		$T_C = 25^\circ\text{C}$	-	4.2	-	$\mu\text{C}$
			$T_C = 125^\circ\text{C}$	-	9.8	-	
$E_{rr}$	Diode Reverse Recovery Energy	$T_C = 25^\circ\text{C}$	-	0.4	-	mJ	
		$T_C = 125^\circ\text{C}$	-	1.2	-		

### Thermal Characteristics

Symbol	Parameter	Test Conditions	Min	Typ	Max	Units
$R_{th(J-C)}$	Thermal Resistance (IGBT Part) <sup>(2)</sup>	Junction-to-Case	-	0.28	-	$^\circ\text{C/W}$
$R_{th(J-C)D}$	Thermal Resistance (Diode Part) <sup>(2)</sup>	Junction-to-Case	-	0.47	-	$^\circ\text{C/W}$

\* This specifications may not be considered as an assurance of characteristics and may not have same characteristics in case of using different test systems from @LSIS. We therefore strongly recommend prior consultation of our engineers.

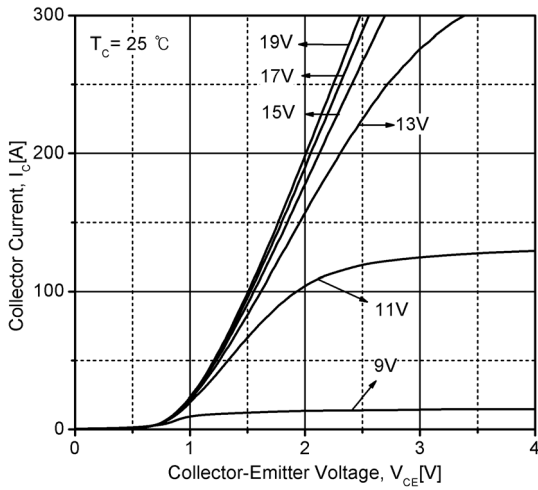

**Fig 1. Typical IGBT Output Characteristics**

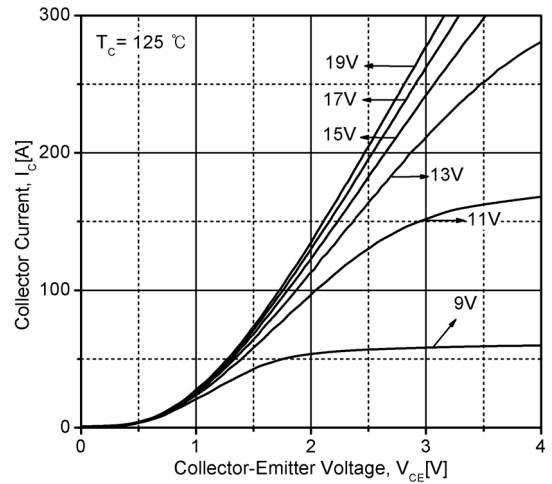

**Fig 2. Typical IGBT Output Characteristics**

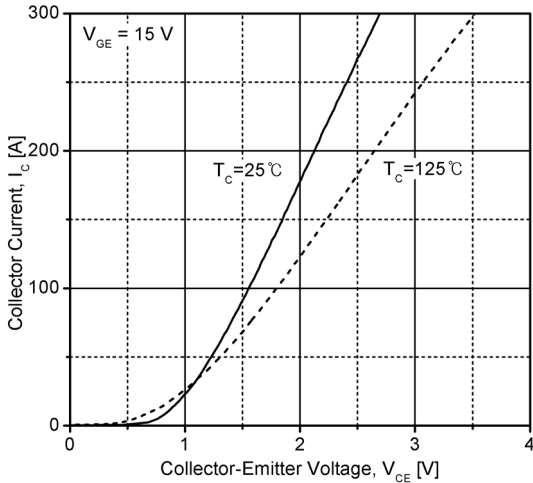

**Fig 3. Typical IGBT Output Characteristics**

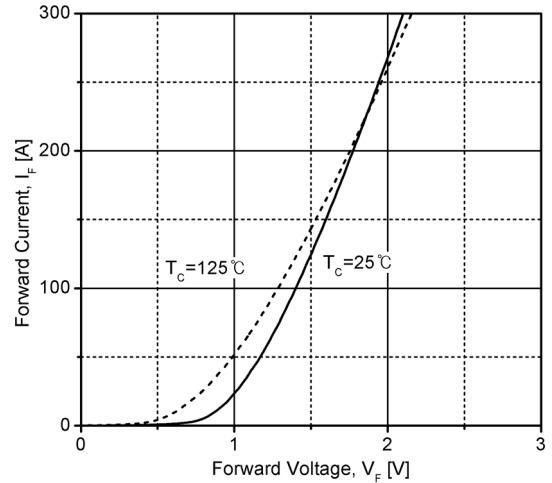

**Fig 4. Typical Diode Forward Characteristics**

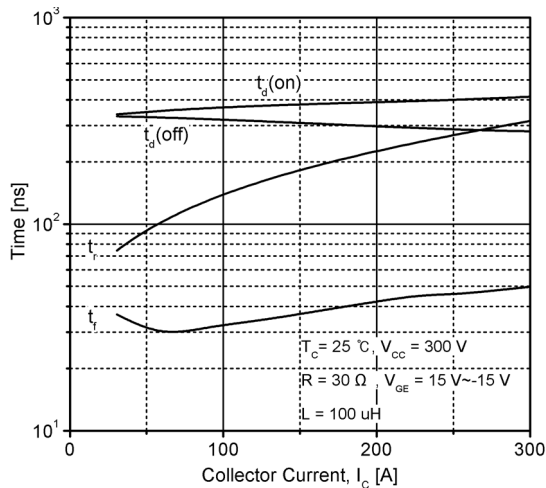

**Fig 5. Typical Switching Time vs. Collector Current**

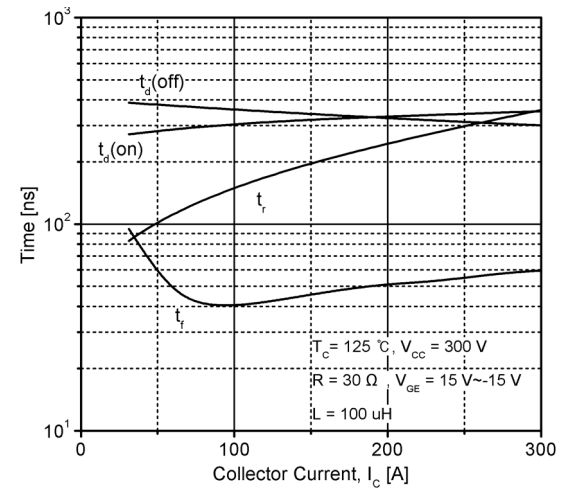

**Fig 6. Typical Switching Time vs. Collector Current**

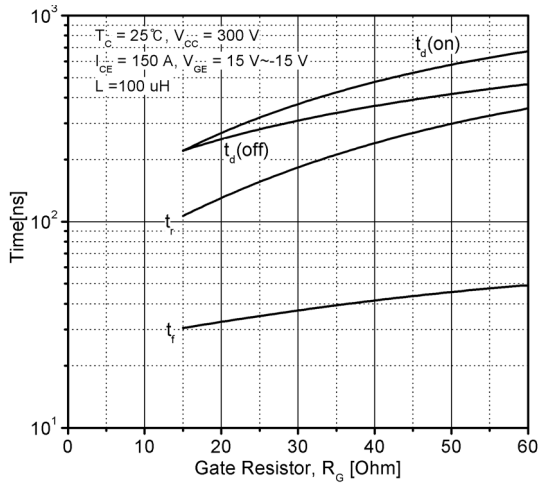

Fig 7. Typical Switching Time vs. Gate Resistor

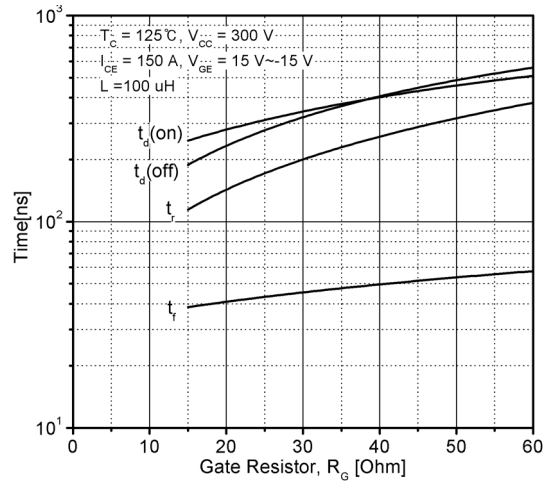

Fig 8. Typical Switching Time vs. Gate Resistor

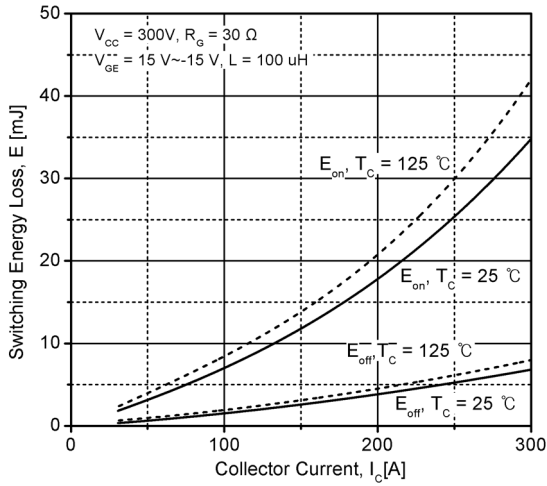

Fig 9. Typical IGBT Switching Loss

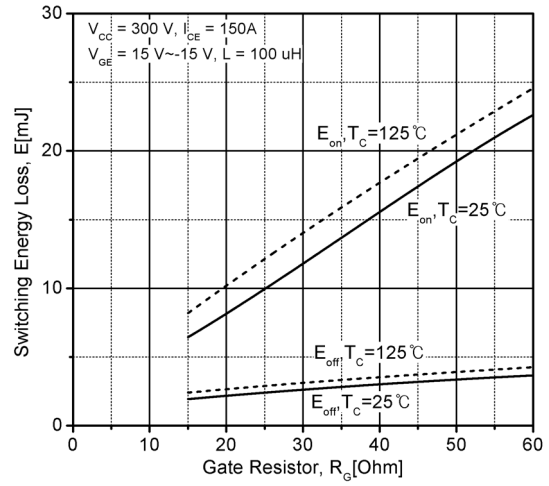

Fig 10. Typical IGBT Switching Loss

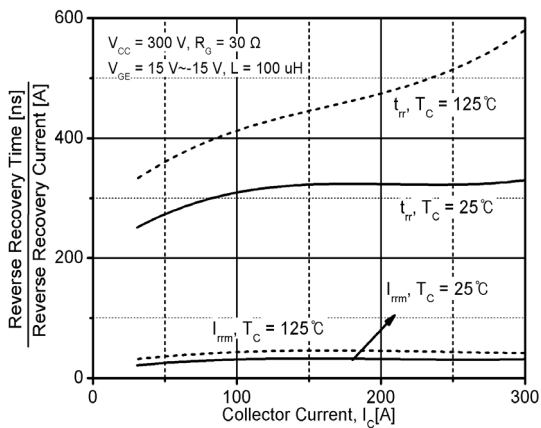

Fig 11. Typical Recovery Characteristics of Diode

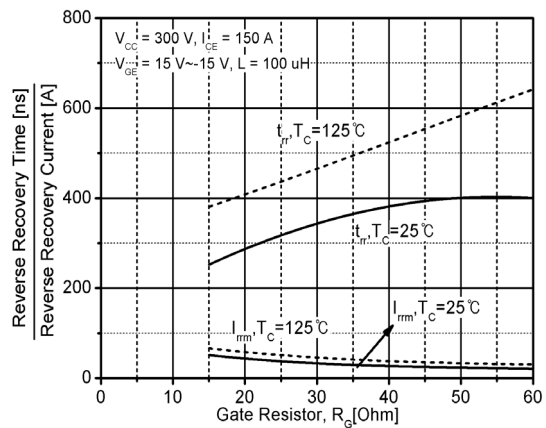

Fig 12. Typical Recovery Characteristics of Diode

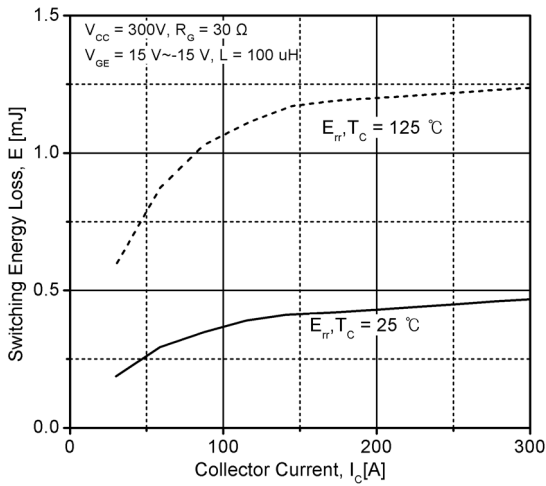

Fig 13. Typical Diode Switching Loss

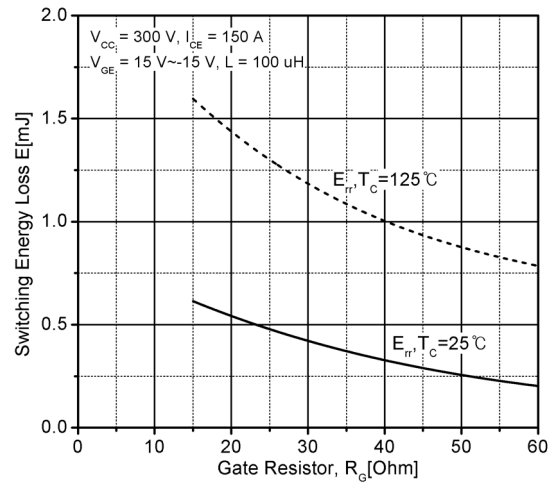

Fig 14. Typical Diode Switching Loss

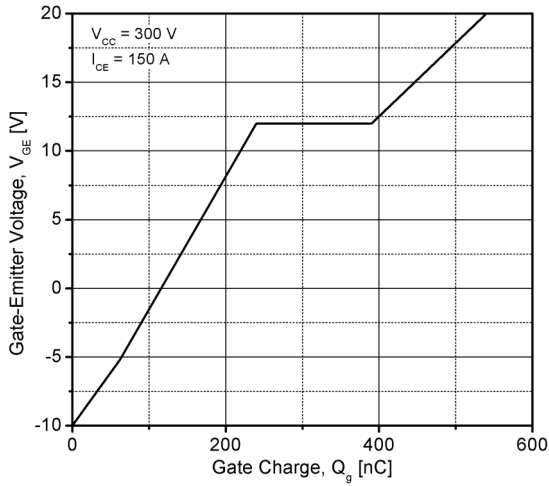

Fig 15. Typical Gate Charge Characteristics

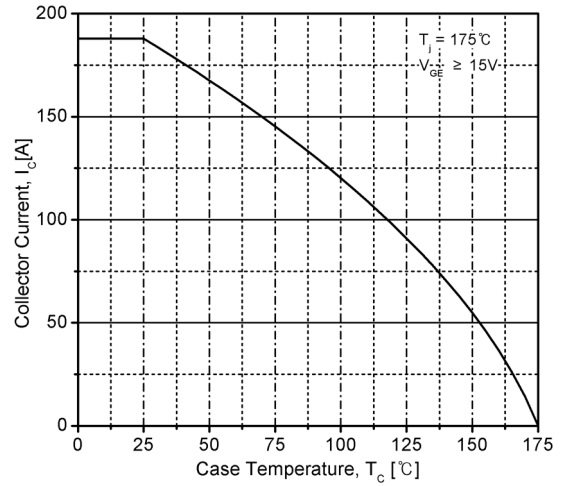

Fig 16. Case Temperature vs. Collector Current

